

The Astonishing Journey of Teddy Bodain Covered Wagon

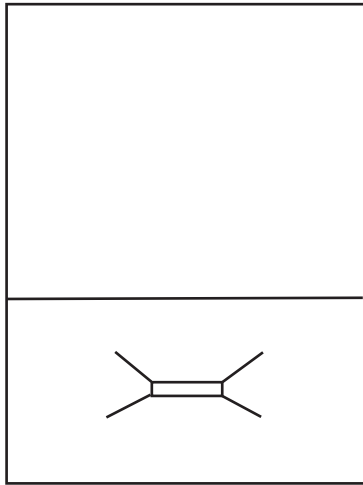

Use a large, unopened, brown paper bag. The bottom of the bag comes folded up over itself.

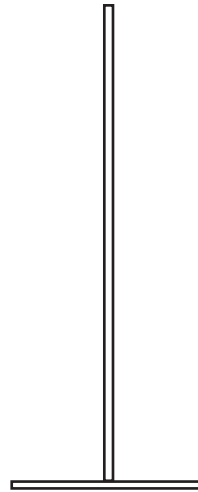

Pull the bottom of the bag down. It looks like an upside down "T" from the side. The bag is still unopened.

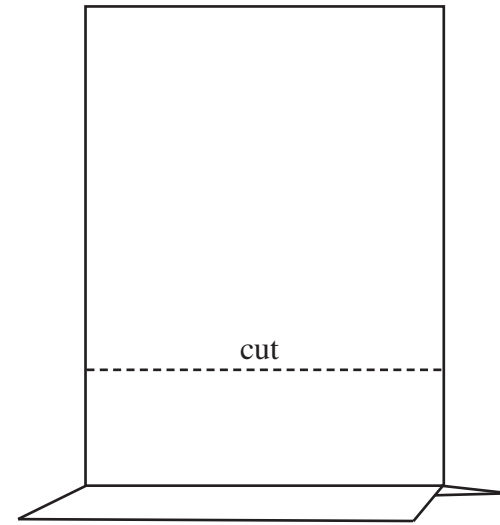

There is a natural fold in the unopened bag, about 3 inches from the bottom. Cut across this line. This cuts most of the top off.

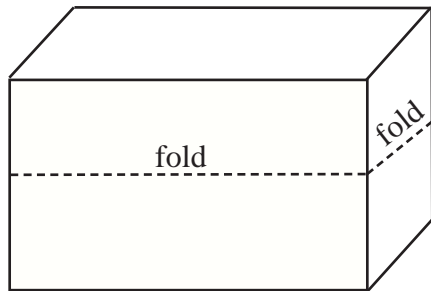

Open the bottom of the bag. Fold the sides of the bag in on themselves so the sides are double. This takes a little doing. Keep smoothing and folding and soon it will be a nice rectangle.

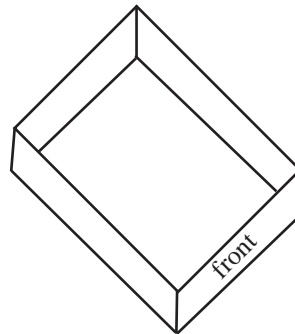

This forms the bottom of the covered wagon. Set this aside.

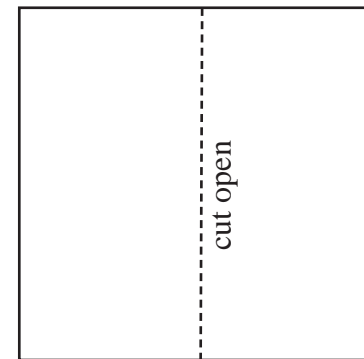

Cut open the top of the bag you cut before.

...The Astonishing Journey of Teddy Bodain Covered Wagon

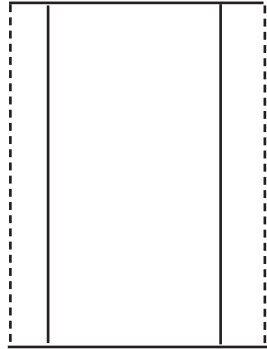

Cut a strip to fit the front of the wagon and add an inch on either side to fold in so the edges will be smooth.

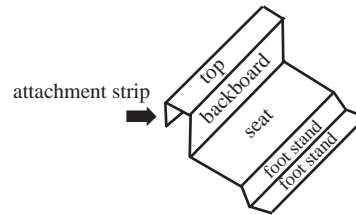

Now fashion a seat from this strip. You will need one fold to attach it to the wagon, one fold for a top, one fold for a backboard, one fold for the seat, and two folds for a foot stand.

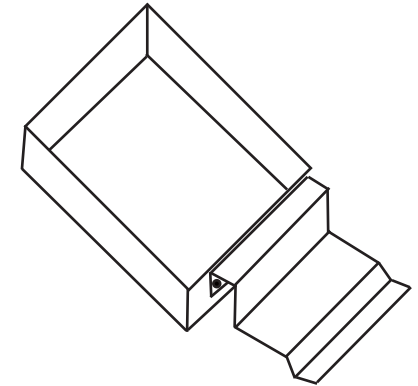

Attach the seat to the front of the wagon with three brass brads. Mark where to put them, then punch holes in the attachment strip and the front of the wagon. Match the holes and insert and open the brads.



You will need 8 fast food drink lids, all the same size. Fit two together and crimp the edges. If the lids are strong enough on their own, just use 4 lids.

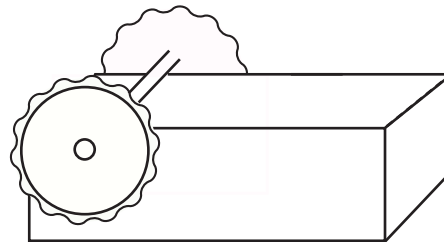

Tape a drinking straw across the bottom of the wagon. This makes the axle. Fit the lid wheels over the end of the straw axle. The wheels don't really roll. They are just for show.

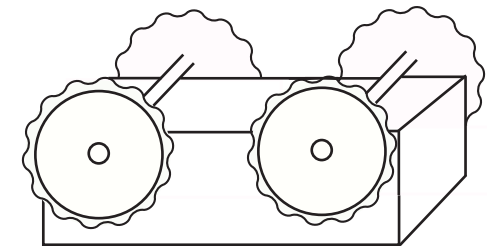

Put a drop of glue between the axle and the wheel to hold it in place. Repeat this entire process for the second set of wheels.

...The Astonishing Journey of Teddy Bodain Covered Wagon

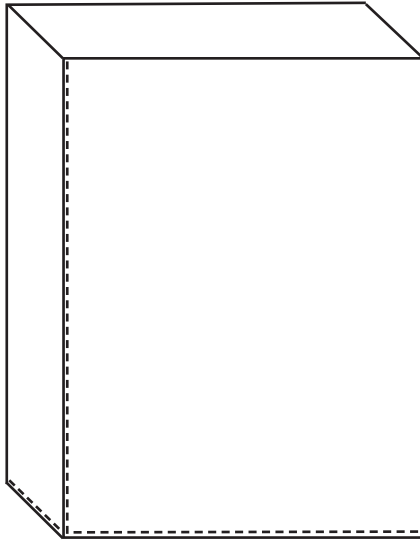

Open a second large, brown paper bag. Cut down one side to the bottom. Cut around the bottom.

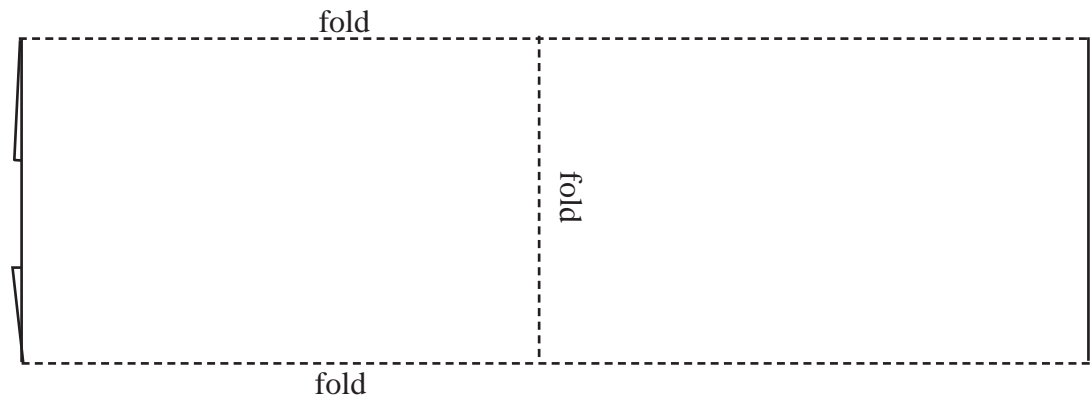

You now have one LONG piece of brown paper. Fold the sides in so the paper measures 12 inches across. Now fold the entire piece in half. This will form the canvas cover for the wagon.

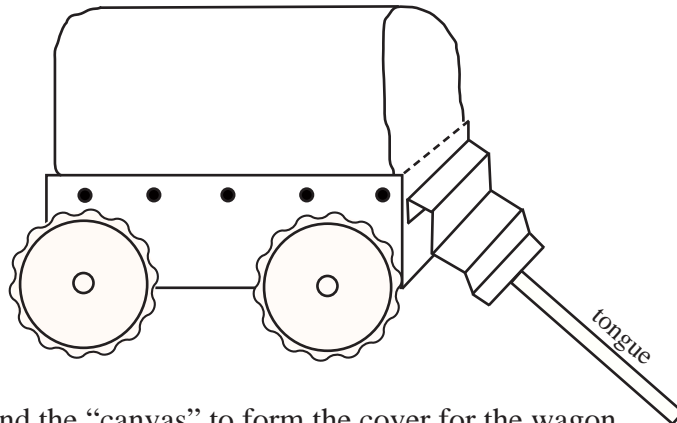

Bend the “canvas” to form the cover for the wagon. You can leave it like this or put a piece of white paper over it. Use a hole punch to punch holes in both the cover and the sides of the wagon. Attach with brass brads.

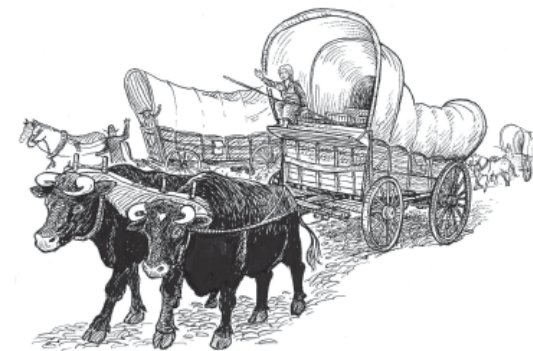

Stores like Target and Michaels carry plastic toys that are miniatures of authentic animals, including oxen and mules. If you'd like, place two oxen in front of your wagon and connect with a brown paper “tongue.” Fold a 10 inch piece of brown paper to form the tongue, and attach it with a brad.